



Patents Pending
FZ1300H

BILLY GOAT Z FORCE BLOWER Owner's Manual

JRCO Universal Mount Not Included

Contact your Billy Goat Dealer or visit <http://jrcoinc.com/> for a list of
JRCO Products



CONTENTS

SPECIFICATIONS _____ 3

SAFETY INSTRUCTIONS AND WARNINGS _____ 4-5

INSTRUCTION LABELS _____ 6

PACKING CHECKLIST _____ 7

ASSEMBLY _____ 8

OPERATION _____ 9

MAINTENANCE AND WARRANTY INFO _____ 10

TROUBLESHOOTING AND WIRING DIAGRAM _____ 11

ILLUSTRATED PARTS LIST _____ 12

PARTS LIST _____ 13

MAINTENANCE RECORD _____ 14



Specifications

FZ1300H

Engine: HP	13.0 HP (9.6kW)
Engine: Model	GX390K1QAA2
Engine: Type	HONDA OHV
Engine: Fuel Capacity	6.5 qt. (6.1L)
Engine: Oil Capacity	1.16 qt. (1.1L)
Total Unit Weight:	192 # (87Kg)
Overall Length:	42"(1.1m)
Overall Width	35.5" (0.90m)
Max operating slope	20 deg.

SOUND



107 dB SOUND LEVEL 87 Db(a) at Operators Position (seated on Zero Turn Mower)

Sound tests were conducted in accordance with 2000/14/EC, as well as ISO 11094, and were performed on 6-30-2011 under the conditions listed below.

 Sound power level listed is the highest value for any model covered in this manual. Please refer to serial plate on the unit for the sound power level for your model.

General Conditions:	Sunny
Temperature:	86°F (30°C)
Wind Speed:	13 mph (20.1 kph)
Wind Direction:	South
Humidity:	62%
Barometric Pressure:	29.94 Hg (101.4 kpa)



GENERAL SAFETY INSTRUCTIONS and SYMBOLS

The safety symbols shown below are used throughout this manual. You should become familiar with them before assembling, operating, or servicing this equipment.



WARNING: This symbol indicates important information that will prevent injury to yourself or others.



This symbol indicates ear protection is recommended when operating this equipment.



This symbol indicates eye protection is recommended when operating this equipment.



This symbol indicates gloves should be worn when servicing this equipment.



This symbol indicates that this manual and the engine manufacturer's manual should be read carefully before assembling, operation, or servicing this equipment.



CAUTION: This symbol indicates important information that will prevent damage to your BILLY GOAT[®] Z FORCE Blower.



This symbol indicates the engine oil level should be checked before operating this equipment.

Read and make sure you thoroughly understand the following safety precautions before assembling, operating or servicing this equipment:



READ this manual and the engine manufacturer's manual carefully before assembling, operating, or servicing this equipment.



EAR PROTECTION is recommended when operating this equipment.



EYE PROTECTION is recommended when operating this equipment.



BREATHING PROTECTION is recommended when operating this equipment.



WARNING: **EXHAUST** from this product contains chemicals known to the State of California to cause cancer, birth defects or other reproductive harm.

DO NOT operate this equipment on any unimproved forested, brushy, or grass covered land unless a spark arrester is installed on the muffler as required by Section 4442 of the California Public Resources Code. The arrester must be maintained in good working order. Other states may have similar laws. Federal laws apply on federal lands.





















DO NOT run engine in an enclosed area. Exhaust gases contain carbon monoxide, an odorless and possibly fatal poison.



Z FORCE BLOWER Owner's Manual



WARNING:

-  **DO NOT** run this equipment indoors or in any poorly ventilated area. Refueling outdoors is recommended.
-  **DO NOT** refuel this equipment while the engine is running. Allow engine to cool for at least two minutes before refueling.
-  **DO NOT** store gasoline near an open flame.
-  **DO NOT** remove gas cap while engine is running.
-  **DO NOT** start or operate engine if strong odor of gasoline is present.
-  **DO NOT** start or operate engine if gasoline is spilled. Move equipment away from spill until gasoline has completely evaporated.
-  **DO NOT** smoke while filling the fuel tank.
-  **DO NOT** check for spark with spark plug or spark plug wire removed. Use an approved spark tester.
-  **DO NOT** operate engine without a muffler. Inspect muffler periodically and replace if necessary. If equipped with muffler deflector, inspect deflector periodically and replace if necessary.
-  **DO NOT** operate engine with grass, leaves or other combustible material near the muffler.
-  **DO NOT** touch muffler, cylinder, or cooling fins when hot. Contact with hot surfaces may cause severe burns.
-  **DO NOT** leave equipment unattended while in operation.
-  **DO NOT** park equipment on a steep grade or slope.
-  **DO NOT** operate equipment with bystanders in or near the work area.
-  **DO NOT** allow children to operate this equipment.
-  **DO NOT** operate equipment with guards removed.
-  **DO NOT** operate equipment near hot or burning debris or any toxic or explosive materials.
-  **DO NOT** operate equipment on slopes greater than specified in Specifications section of this manual.
-  **DO NOT** operate near steep embankments or drop offs.
-  **DO NOT** transport this unit attached at excessive speeds, doing so may result in serious injury or death.

ALWAYS make sure the machine is attached to the mower securely.

ALWAYS remove spark plug wire when servicing equipment to prevent accidental starting.

ALWAYS wear your seatbelt when using this machine.

ALWAYS check fuel lines and fittings frequently for cracks or leaks. Replace if necessary.

ALWAYS keep hands and feet away from moving or rotating parts.

ALWAYS store fuel in approved safety containers.

ALWAYS shut of gas flow valve when transporting machine.



WARNING: Important

Do not run this machine without exhaust elbow attached.



DO NOT run this machine with a cracked or damaged impeller under any circumstances.



INSTRUCTION LABELS

The labels shown below were installed on your BILLY GOAT® Z FORCE Blower. If any labels are damaged or missing, replace them before operating this equipment. Item numbers from the Illustrated Parts List and part numbers are provided for convenience in ordering replacement labels. The correct position for each label may be determined by referring to the Figure and Item numbers shown.



**LABEL SPARK ARRESTOR
P/N 100252**



**DANGER FLYING DEBRIS
ITEM # 18 P/N 810736**



**LABEL THROTTLE CONTROL
ITEM # 72 P/N 810656**



**LABEL WARNING FZ
ITEM #2 P/N 442500**

ENGINE LABELS

HONDA

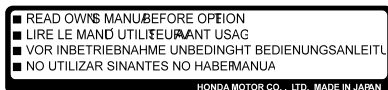



PACKING CHECKLIST

These items should be included in your carton. If any of these parts are missing, contact your dealer. Your BILLY GOAT® Z FORCE Blower was shipped in one carton, completely assembled. Mounting hardware can be found on the attachment points on the frame.



READ all safety instructions before attaching unit.

TAKE CAUTION when removing the unit from the box the switch pedal assembly is attached by cables.



PUT OIL IN ENGINE BEFORE STARTING

PARTS BAG & LITERATURE ASSY

Warranty card P/N- 400972, Owner's Manual P/N-442503

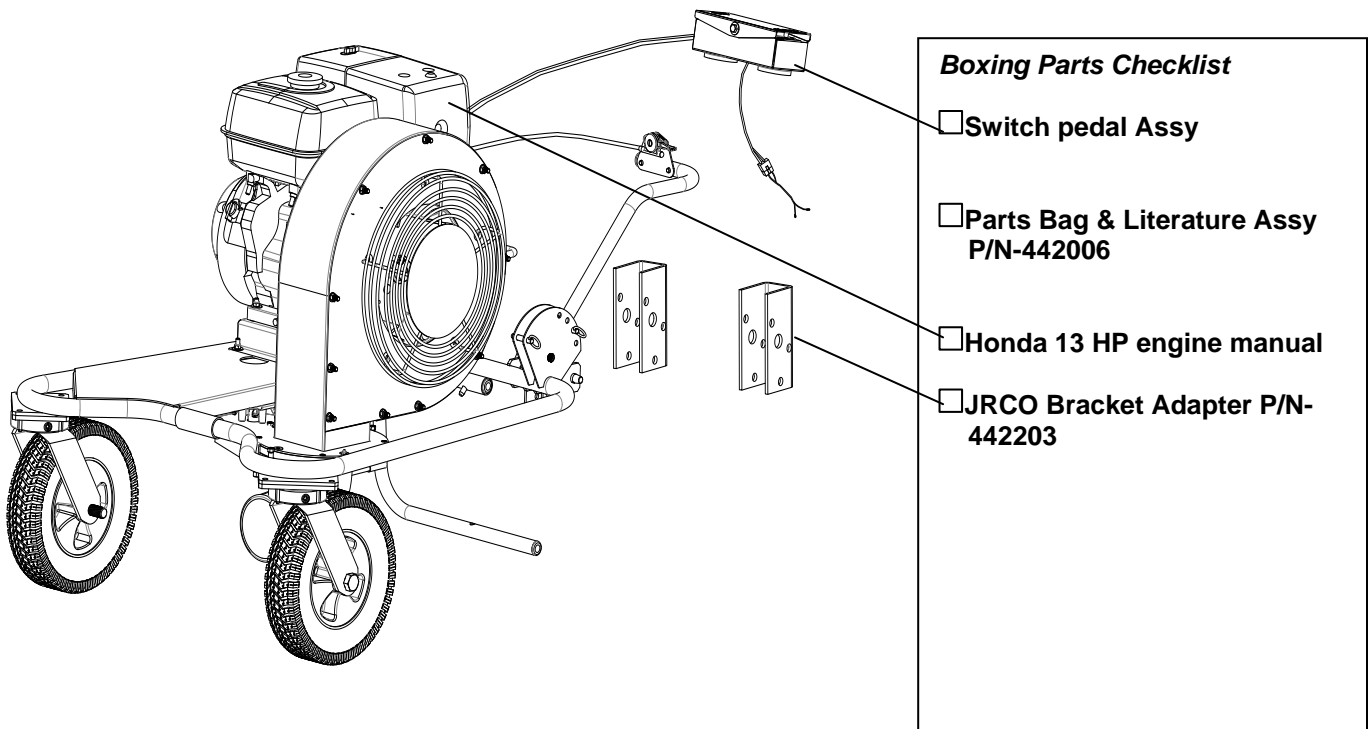

ASSEMBLY

1. Follow the steps in figures A and B, then securely tighten all hardware shown.
2. Connect spark plug wire on the blower.

Figure A

Make sure your JRCO bar is attached to your mower. Then replace the mounting bracket with the bracket provided (item 4). Attach the Blower to brackets and install the pins making sure they are completely pushed in. NOTE some JRCO bars will require mounting to the outside ears of the blower bracket (15" Center).

Ensure the unit is mounted level, failure to do so may result in poor handling and will put stress on the blower frame. Level the unit by adjusting the mounting brackets (item 4) up or down depending on your mower.

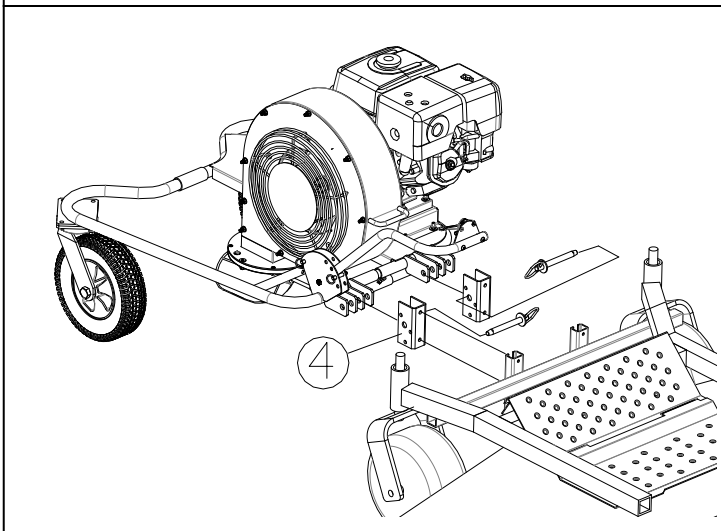
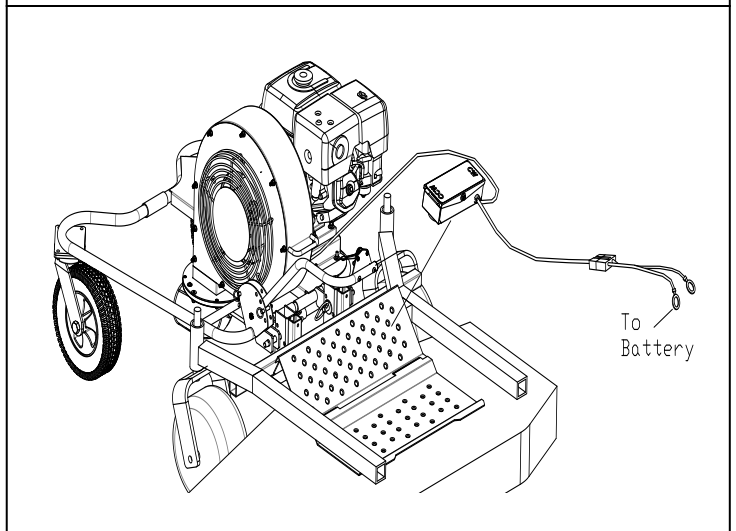
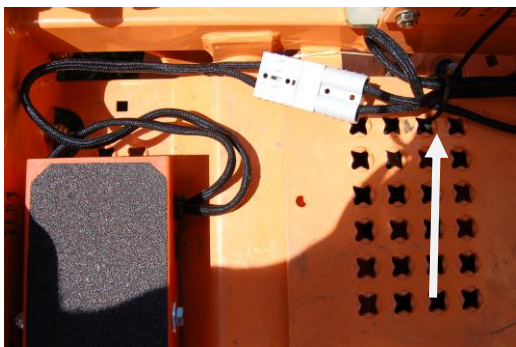

Figure B

Connect the rear portion of the wiring harness to the mower battery by attaching the red wire to the positive terminal and the black wire to the negative terminal. Route the harness so that the connector is located at the foot rest portion of the mower. **Note** make sure the position of the switch box will not interfere with mower operation controls. Secure any excess length of wire to the frame of the mower using ty wraps. **FAILURE TO CONTAIN EXCESS WIRE WILL RESULT IN WIRE COMING INTO CONTACT WITH MOVING PARTS ON MOWER (belts, blades, brake pedals, etc.) FAILURE TO PROPERLY SECURE WIRING HARNESS WILL RESULT IN FAILURE AND IS NOT COVERED UNDER WARRANTY!**



Proper mounting
Wires tied down



Improper mounting
Wires not tied down

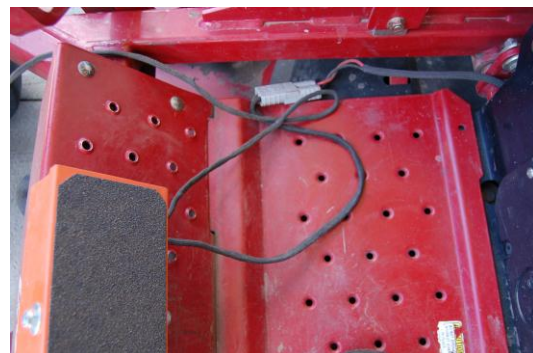



BLOWING OPERATION

Your Billy Goat Z Force blower is equipped with a motorized air director nozzle to allow the operator to direct the air stream by rotating left or right as required to assist in moving debris. This feature is extremely useful when having to move debris in various directions.

Always make sure the kickstand is up before unit is put in motion to raise the kickstand pull out the pin and rotate the kickstand up towards the blower. Locate the hole that holds it in the upwards position and re-insert the pin. Likewise, before detaching the unit from the mower make sure the kickstand is down and locked in position.

ADJUSTING AIR DIRECTOR

To change the air direction use the foot pedal switch to rotate the nozzle clockwise (CW) or counter-clockwise (CCW). Use the red indicator as a visual guide to show which way the nozzle is pointing when out of view. **Note:** Switch must be hooked up to battery in order to function.

⚠ DO NOT position exhaust nozzle to where it will blow debris towards people, vehicles or other objects in vicinity. Flying debris may damage, harm, or cause injury to people or objects in air flow range.

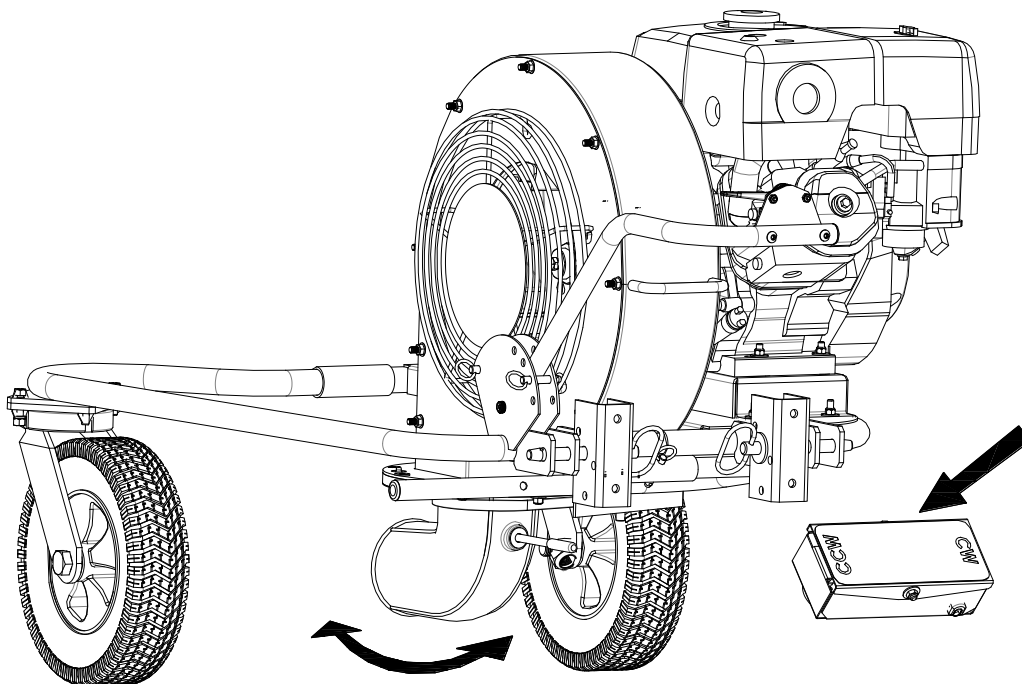



MAINTENANCE

PERIODIC MAINTENANCE

Periodic maintenance should be performed at the following intervals:

Maintenance Operation	Every Use	Daily or Every 5 Hours	Every 25 Hours	Every 50 Hours	Every 100-150 Hours
Inspect for worn or damaged parts.	•				
Check for excessive vibration		•			
Grease Casters and Exhaust elbow					•
Inspect Impeller for cracks or damage					•
Inspect for loose parts.		•			

IMPELLER REMOVAL

1. Wait for engine to cool and disconnect spark plug.
2. Remove housing front cover, by removing (11) nuts, items #49, around outside of front cover.
3. Remove impeller bolt (item #12), lock washer (item #8) and washer (item #38).
4. DO NOT pry on impeller. Pull on center hub area only of impeller. *Using a penetrating oil can help loosen a stuck impeller.*
5. Reinstall new impeller in reverse order of removal using new hardware including the key.
6. Tighten impeller bolt. Torque impeller bolt (see parts list on page 13 for proper impeller bolt torque specifications).

When servicing engine refer to specific manufacturer's engine owner's manual. Engine warranty is covered by the specific engine manufacturer. If your engine requires warranty or other repair work, contact your local servicing engine dealer. When contacting a dealer for service it is a good idea to have your engine model number available for reference (See table page 3). If you cannot locate a servicing dealer in your area you can contact the manufacturer's national service organization.

To reach:

American Honda: 800-426-7701

WARRANTY CLAIM PROCEDURE

Should a BILLY GOAT[®] machine fail due to a defect in material and/or workmanship, the owner should make a warranty claim as follows:

- The machine must be taken to the dealer from whom it was purchased or to an authorized Servicing BILLY GOAT Dealer.
- The owner must present the remaining half of the Warranty Registration Card, or, if this is not available, the invoice or receipt.
- The Warranty Claim will be completed by the authorized BILLY GOAT Dealer and submitted to their respective BILLY GOAT Distributor for their territory Attention: Service Manager. Any parts replaced under warranty must be tagged and retained for 90 days. The model number and serial number of the unit must be stated in the Warranty Claim.
- The distributor service manager will sign off on the claim and submit it to BILLY GOAT for consideration.
- The Technical Service Department at BILLY GOAT will study the claim and may request parts to be returned for examination. BILLY GOAT will notify their conclusions to the distributor service manager from whom the claim was received.
- The decision by the Technical Service Department at BILLY GOAT to approve or reject a Warranty Claim is final and binding.

For online product registration go to www.billygoat.com



TROUBLESHOOTING

Problem	Possible Cause	Solution
Abnormal vibration.	<ul style="list-style-type: none"> Loose or out of balance impeller. Debris in impeller. Loose engine. 	<ul style="list-style-type: none"> Check impeller and replace if required. Clear debris with compressed air or a backpack blower (see below pictures).* Check engine.
Engine will not start.	<ul style="list-style-type: none"> Engine not in full choke position. Out of gasoline or bad, old gasoline. Spark Plug wire disconnected. Gas valve off. Dirty air cleaner. 	<ul style="list-style-type: none"> Check choke position. Check gasoline. Connect spark plug wire. Turn on gas valve. Clean or replace air cleaner. Contact a qualified service person.
Engine is locked, will not pull over.	<ul style="list-style-type: none"> Engine problem. 	<ul style="list-style-type: none"> Contact an engine servicing dealer for engine problems.
Exhaust elbow not rotating	<ul style="list-style-type: none"> Grease on elbow Broken belt Battery cable not connected or battery is dead Belt off of motor pulley 	<ul style="list-style-type: none"> Clean off excess grease on elbow Replace belt Check battery connections Charge or replace battery Put belt back on pulley

*Using compressed air, or a Backpack blower, you can loosen or free debris easily from the impeller and housing, debris can cause wear and tear on the machine. Note: Always disconnect the sparkplug when servicing.



Z FORCE WIRING DIAGRAM

Replace fuse with-
20 amp bus type fuse

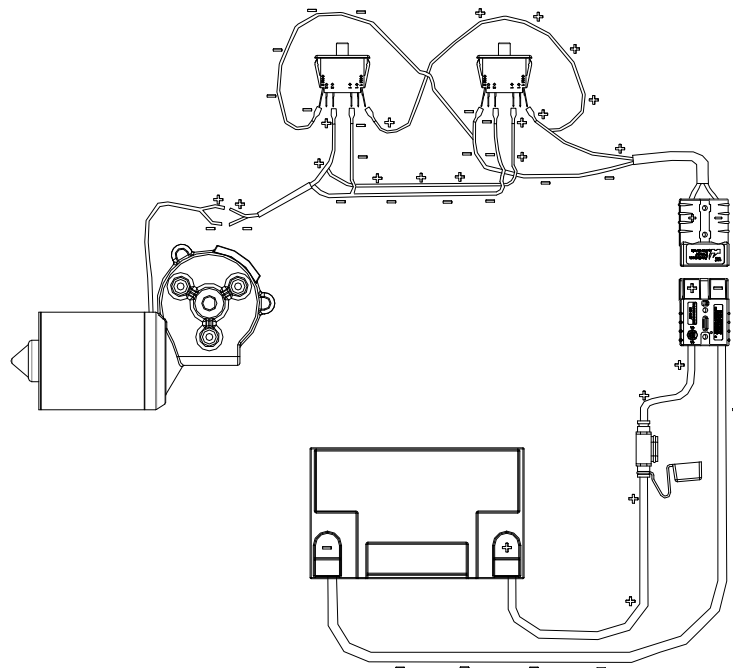

ILLUSTRATED PARTS LIST

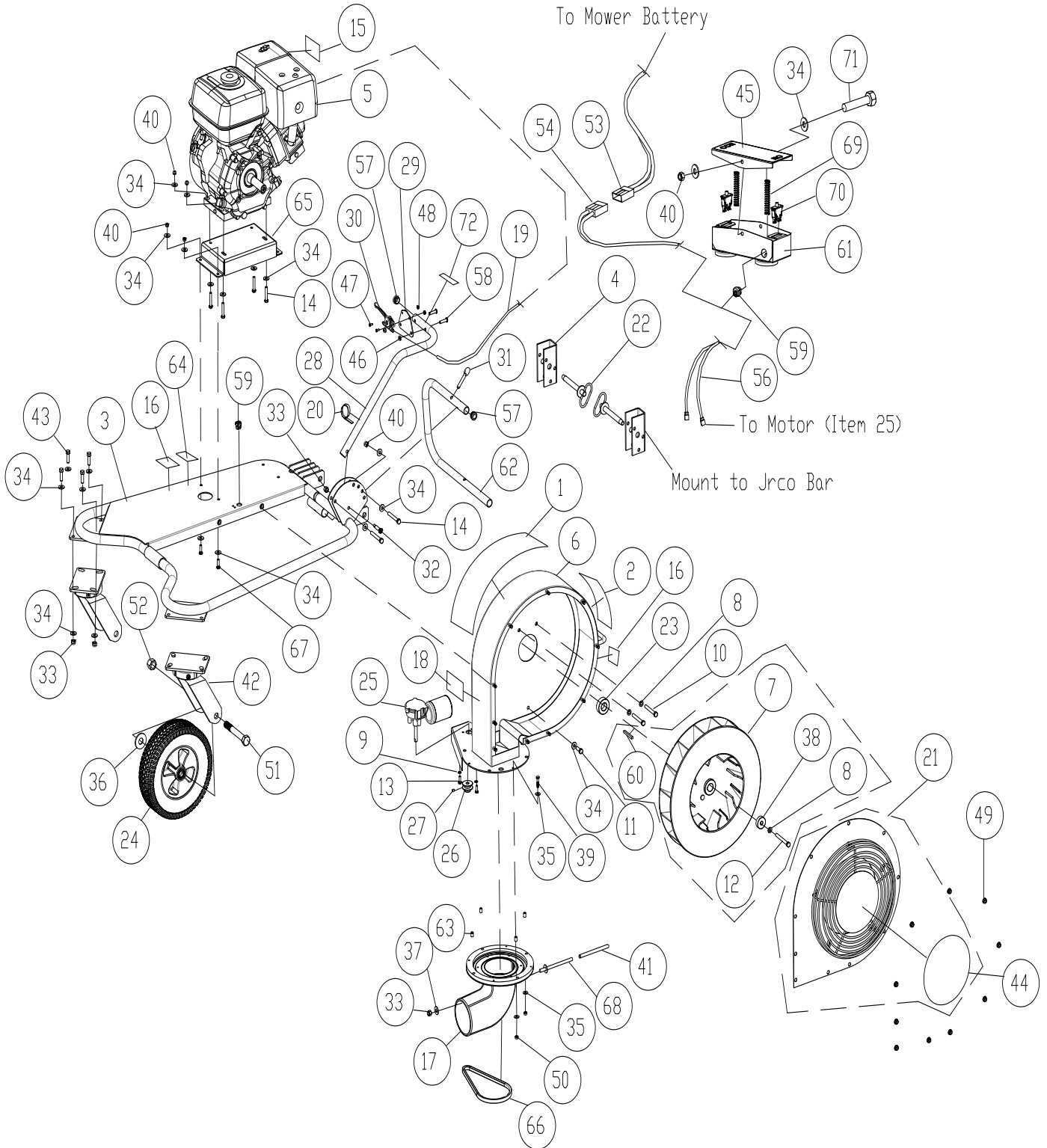



PARTS LIST

Item No.	Part No.	Description	Qty	Item No.	Part No.	Description	Qty
1	442501	LABEL LOGO FZ	1	37	8171004	WASHER 3/8" FC	1
2	442500	LABEL WARNING FZ	1	38	440176	WASHER 1.5 OD X .453 ID X .5 THK	1
3	442600	FRAME WA FZ W/LABELS	1	39	8041007	SCREWCAP 1/4"-20 X 1 1/4" HCS MED	4
4	442203	JRCO BRACKET	2	40	8160002	NUT LOCK 5/16" - 18 HEX ZP	19
5	440018	ENGINE 13 HP HONDA	1	41	442243	CAP INDICATOR RED	1
6	442601	HOUSING WA FZ W/LABELS	1	42	442200	CASTER RIG 12"	2
7	442602	IMPELLER ASSY FZ	1	43	8041051	SCREWCAP 3/8 - 16 X 1 1/4" HCS ZP	8
8	8177012	WASHER LOCK 3/8" S/T MED	3	44	440268	LABEL LOGO FORCE	1
9	8177010	WASHER LOCK 1/4" S/T MED	3	45	442604	SWITCH BOX TOP PLATE W/TREAD TAPE	1
10	8041057	SCREWCAP 3/8"-16 X 2 3/4" HCS ZP	2	46	8161041	NUT LOCK 5/16" TH HT HEX ZP	2
11	8041050	SCREWCAP 3/8"-16 X 1" HCS ZP	2	47	830514	SCREW MACH #10-24 X 1/2"	2
12	442237	SCREWCAP 3/8"-24 X 3 1/4" GR. 8 HCS	1	48	8164005	NUT LOCK #10 - 32	2
		TORQUE TO 38 +/- 2 ft. lbs.		49	350346	NUT FLANGE 5/16" - 18 ZP	10
13	442236	SCREWCAP 1/4"-28 X 3/4"	3	50	8160001	NUT LOCK 1/4 - 20	4
14	8041031	SCREWCAP 5/16" - 18 X 1 3/4" HCS ZP	6	51	8041175	SCREWCAP 3/4 - 10 X 5 1/2"	2
15	442506	LABEL GAS SHUT OFF	1	52	8161006	NUT LOCK 3/4"-10 ZP	2
16	360187	LABEL LIFT HERE	2	53	442213	HARNESS WIRE FZ BATTERY	1
17	442605	ELBOW EXHAUST ASSY	1	54	442214	HARNESS WIRE ROTATOR SWITCH	1
18	810736	LABEL WARNING DEBRIS	1	55	360243	LANYARD PLASTIC 10"	1
19	440178	CABLE THROTTLE 31.5	1	56	442215	HARNESS WIRE CONTROL	1
20	900407	TY-WRAP	1	57	890132	PLUG TUBE INSERT 1" OD	3
21	442603	PLATE FRONT WA FZ W/LABEL	1	58	442204	SCREW BUTTON HEAD 5/16-18 X 1 1/4"	2
22	442202	PIN HITCH 5/8" X 4 1/2"	2	59	500282	STRAIN RELIEF	2
23	442231	SPACER CRANK FZ13H	1	60	9201123	KEY 1/4" SQ X 2.25"	1
24	442247	WHEEL 12" X 3" RIM W/ 3/4" STEEL BEAR	2	61	442103	SWITCH BOX WA	1
25	442205	MOTOR 12V	1	62	442401	TUBE KICK STAND	1
26	442240	PULLEY 1.63" OD X 7/16" BORE	1	63	442241	STAND OFF NOZZLE FZ	4
27	8083122	SET SCREW 1/4" - 20 X .375 CUP POINT	1	64	520116	LABEL MADE IN USA	1
28	442400	THROTTLE STEM	1	65	442105	STAND OFF ENGINE FZ WA	1
29	500385	THROTTLE PLATE	1	66	500119	BELT GATES TRUFLEX 1260	1
30	440013	CONTROL THROTTLE	1	67	8041028	SCREWCAP 5/16" - 18 X 1 1/4" HEX ZP	4
31	510130	PIN 3/8" X 1 1/2" DETENT	1	68	442106	INDICATOR DIRECTION WA	1
32	360284	BOLT SHOULDER 3/8" X 1"	1	69	442216	SPRING .578 OD X 3.16 LONG	2
33	8160003	NUT LOCK 3/8"-16	10	70	791095	SWITCH ROTATOR	2
34	8171003	WASHER 5/16" FC	40	71	8041041	SCREWCAP 5/16 -18 X 4 1/2"	1
35	8171002	WASHER 1/4" FC	8	72	810656	LABEL THROTTLE CONTROL	1
36	8171008	WASHER 3/4" FC	2				



MAINTENANCE RECORD

Date	Service Performed

